

# Fakra HFR3C – 8mm Duplex Male Housing

Cable type **RG174** (2.6/50) & **RTK** (3.2/50)



R197.236.\_80

TECHNICAL DATA SHEET

Rev	Date	Edited	Approved	Validated	Modification
1	14/03/2018	C.Chavanne	Y.Gay	R.Chantre	Creation

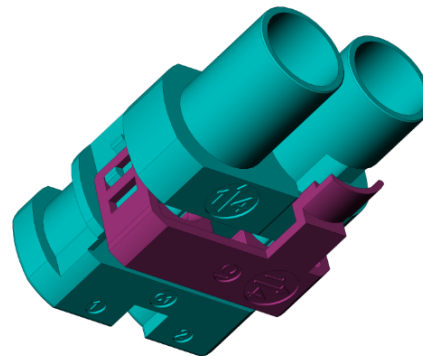
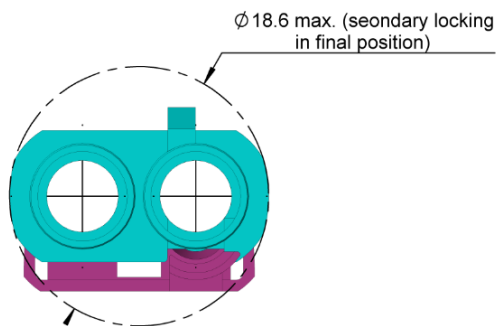
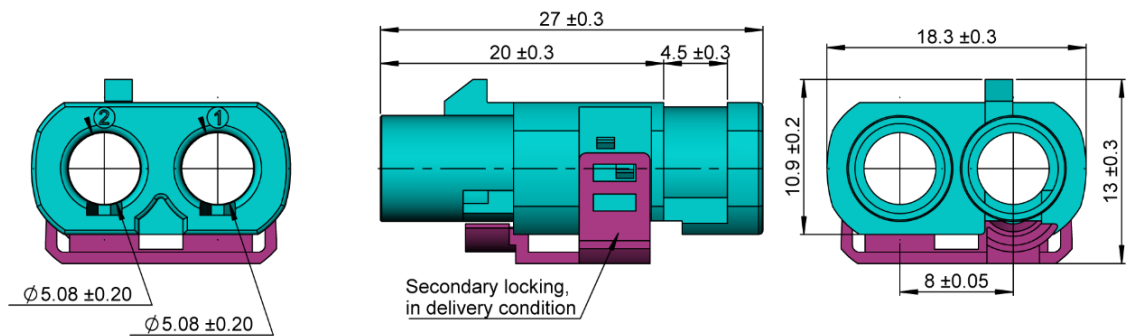

All dimensions are in mm

COMPONENTS	MATERIALS	UL CLASSIFICATION	COLOR
Housing	Polyamide	UL 94 V-2	See page 2
Secondary locking	Polyamide	UL 94 V-2	Purple

# Fakra HFR3C – 8mm Duplex Male Housing

Cable type **RG174** (2.6/50) & **RTK** (3.2/50)



R197.236.\_80

TECHNICAL DATA SHEET

## Interface

According to ISO 20860-1

## Application

This housing is part of an assembly to create a complete HFR3C connector. It has to be assembled with a terminal and a ferrule.

Refer to **AI\_HFR3C** to get the corresponding P/N.

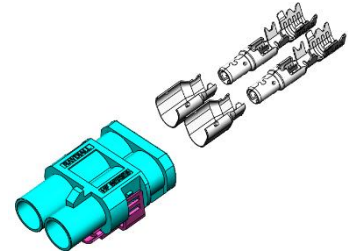

## Codings

To obtain the complete part number, please fill in the blank “\_” with the coding letter.

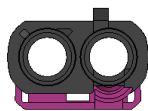

**A**

Black  
9005

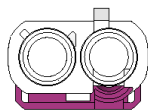

**B**

Crème White  
9001

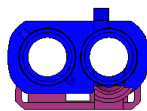

**C**

Blue  
5005

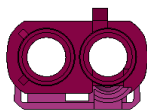

**D**

Bordeaux  
4004

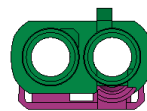

**E**

Green  
6002

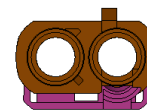

**F**

Brown  
8011

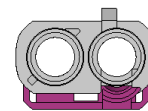

**G**

Grey  
7031

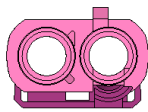

**H**

Violet  
4003

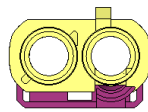

**I**

Beige  
1001

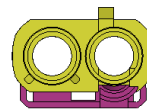

**K**

Curry  
1027

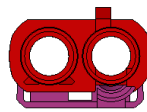

**L**

Carmin  
3002

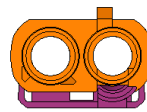

**M**

Pastel Orange  
2003

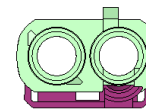

**N**

Pastel Green  
6019

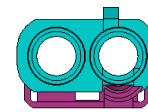

**Z**

Water blue  
5021

**Net weight:** 2.35g

## Storage condition & Shelf Life

Boxes should be stored indoors, in its original packaging (box + plastic bag), in a controlled climate environment not exceeding -20°C/+40°C and maximum 70% relative humidity. The boxes should be protected from direct sunlight and should be used on a "first-in, first-out" basis.

It is recommended to use this reference within 1 year from the date of manufacture when stored according to the recommended storage condition.

## Product Handling

Care must be taken when handling the carton boxes of housings. They must not fall. Indeed it might unwillingly activate the secondary locking, which makes the housing un-usable.

Fakra HFR3C – 8mm Duplex Male Housing

Cable type **RG174** (2.6/50) & **RTK** (3.2/50)



R197.236.\_80

TECHNICAL DATA SHEET

**Packaging: Cardboard box**

48 small boxes inside 1 cardboard box with following characteristics:

- Dimensions: 35x40x40 cm
- Weight: ≈ 15.5kg

Total Number of housings / cardboard box: 4800 pcs



Inside the Cardboard box: 48 small boxes